

CORONA

850 m³/h
High Efficiency Motor



CORONA X 90

Cod. **02189306** EAN **8422248082327**

- Electronic Control Panel** with digital display automatic shut-down timer
- 3 extraction levels, 2 + 1 **TURBO**
- Extraction power (according to UNE/EN 61591): **850m³/h** - 340m³/h
- Maximum air flow (free outlet): **1200m³/h**
- Sound power (Reg.(EU) nº65/2014): 50dB(A)**, maximum: 65dB(A)
- BT3 motor. Ultra silent. Maximum energy consumption **280W**
- High efficiency strip led lighting**
- Easy-to-install system
- Fully stainless steel washable dishwasher filters
- Glass Visor**
- Stainless steel finishing
- Max. Pressure: 470 Pa
- 150/125 mm outlet diameter
- Energy Class: A**

► **Accessories (not included)**

Active charcoal filter Cod. 02859398 / EAN 8422248075497
 Check valve Cod. 02832004 / EAN 8422248480499

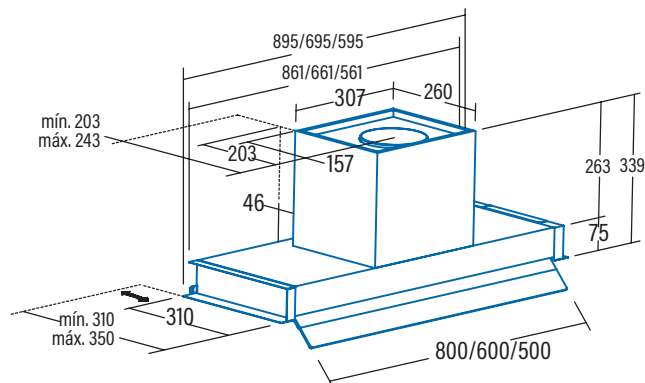

Code	02189306
EAN	8422248082327
Model	CORONA X 90
Type	Integrated
Product fiche according to directives EU65/2014 - EN61591, EN60704-2-13, EN50564	
AEC (Annual Energy consumption) (kWh/annum)	53,6
EI class (Energy Efficiency Class)	A
FDE (Fluid Dynamic Efficiency)	30,6
FDE class (Fluid Dynamic Efficiency Class)	A
LE (Lighting Efficiency) (lux/W)	55,7
LE class (Lighting Efficiency Class)	A
GFE (Grease Filtering Efficiency)	91,2
GFE Class (Grease Filtering Efficiency class)	B
Air flow at minimum speed (m ³ /h)	340
Air flow at maximum speed (m ³ /h)	600
Air flow at intensive speed (TURBO) (m ³ /h)	850
Sound Power Level at minimum speed (dB)	50
Sound Power Level at maximum speed (dB)	65
Sound Power Level at intensive speed (TURBO) (dB)	67
Po (Power Consumption in off mode) (W)	0,26
Ps (Power Consumption in standby) (W)	0
Integration directive EU 66/2014	
f (Time Increase Factor)	0,9
EI (Energy Efficiency Index)	52,1
QBEP (Flow Rate at Best Efficiency Point) (m ³ /h)	416,9
PBEP (Static Pressure Difference at Best Efficiency Point) (Pa)	411
WBEP (Electric Power Input at Best Efficiency Point) (W)	155,7
WL (Nominal Power Consumption of Lighting system) (W)	3,5
EMIDDLE (Average Illumination of Lighting system on Cooking surface) (lux)	195
External Dimensions	
Width (mm)	895
Depth (mm)	310-350
Total max height (mm)	339
Total min height (mm)	339
Outlet Diameter (mm)	150/125
Characteristics	
Motor	BT3
Extraction Levels	2 + 1
Motor Maximum Power Consumption	280
Maximum Pressure	450
Intensive Speed (TURBO) Pressure	470
Control Type	VL3i
Automatic shut-down timer	√
Electronic Filter Saturation Indicator	-
Filter Type	Metallic
Anti-grease Filter Number	2
Inner Shield	-
Lighting	
Light Type	Eco Led Strip
Adjustable Intensity Lighting	-
Nº of Lamps	1
Installation	
Minimum height distance to a electric worktop hob (mm)	550
Minimum height distance to a gas worktop hob (mm)	650
Installation with Outlet tube to the exterior / Recirculating	BOTH
Easy Installation System	√
Electric Connection	
Total Rush Power (W)	283,5
Rated Voltage (V)	220-240
Network Frequency (Hz)	50
Electrical Insulation Class	CLASS II
Plug	EU - 2 pins
Accessories	
Upper Decorative tube Extension	-
White Decorative Tube	-
Black Decorative Tube	-
Island Tube Enhancer	-
Check Valve	02832004
MAX PRO Metal Filter	-
Metal Filter	02800205
DUAL Filter (metal + active charcoal)	-
Active Charcoal Filter	02859398
Noiseless Flexible Duct	02893002